

# XS-4 Parts

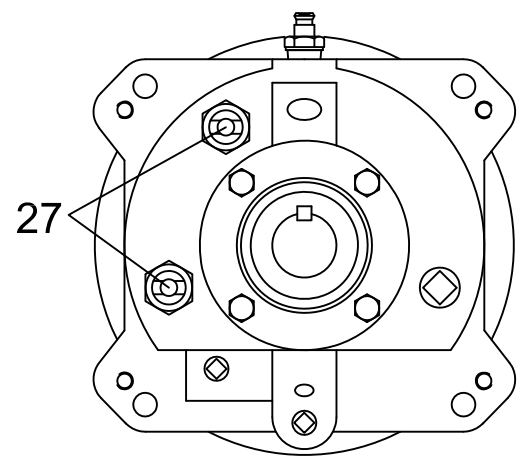

# XS-4 Parts

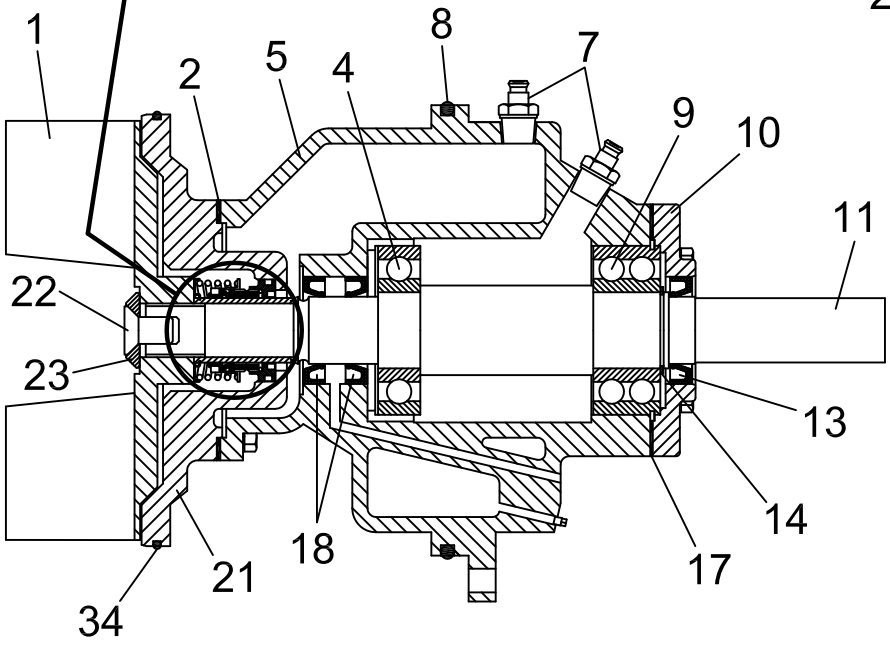
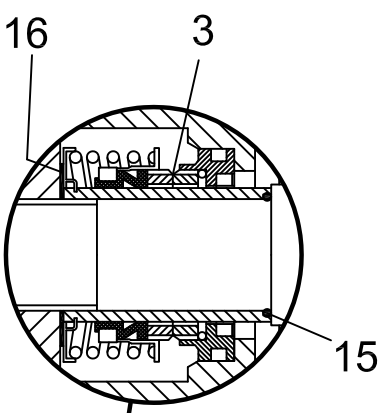
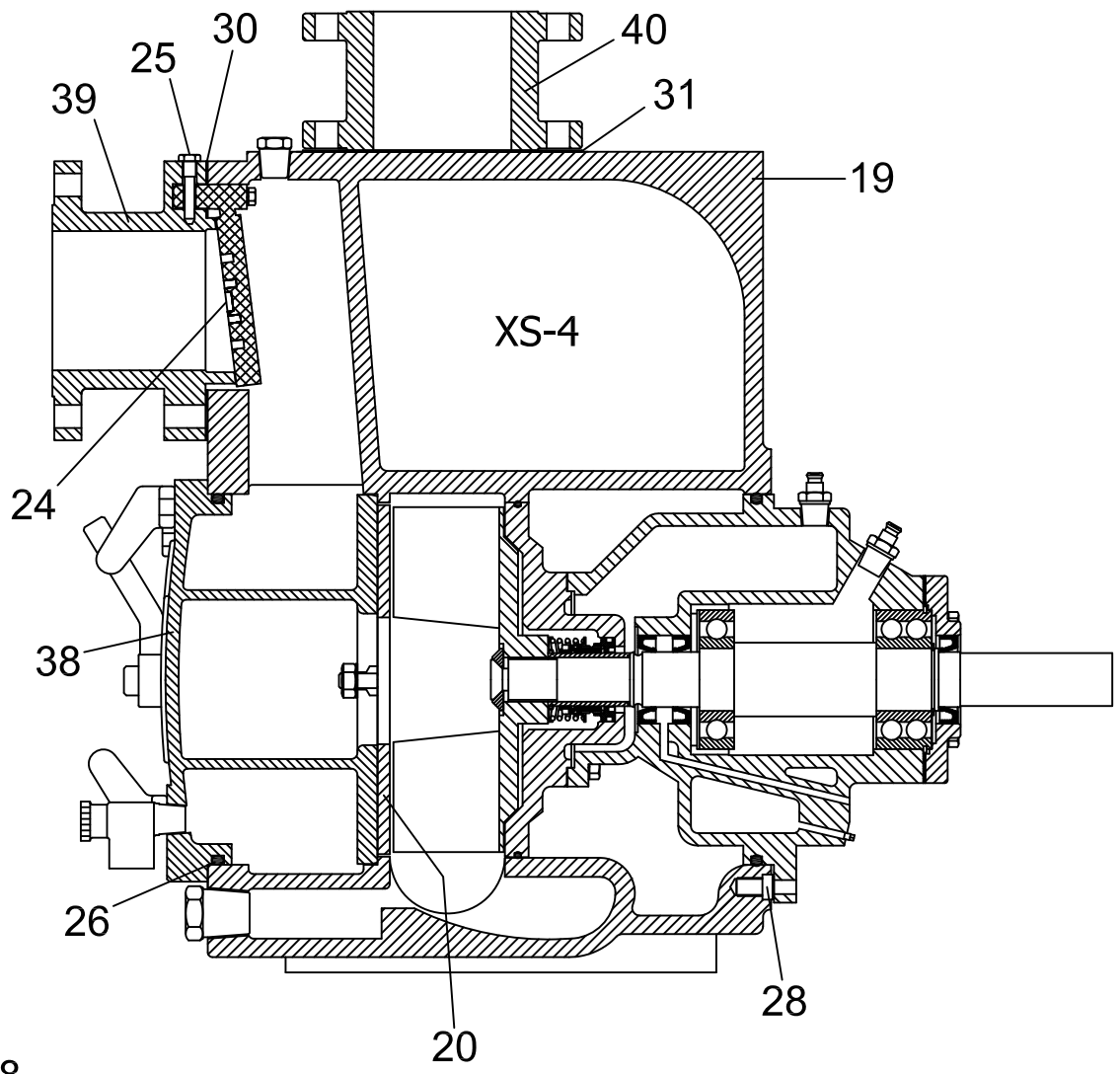
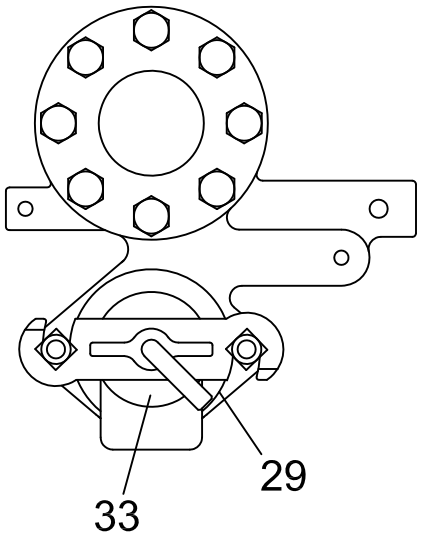

**ALL PRIME PUMPS**  
p. 800-803-0353

<i>item</i>	<i>description</i>	<i>AP part no.</i>	<i>GR part no.</i>
1*	impeller S4,XS4 - D/I(std)	312.010.100	10528-11010
1*	impeller S4,XS4 - CD4	312.010.104	10528-1718H
2*	gasket, seal plate S346, XS346, I34	311.010.200	10959G-20000
3*	seal, mech. - 1.5" (cart.w/sleeve) Δ	310.010.310	46513-151
3*	seal, mech. - 1.5" (comp.no-sleeve) ▲	310.010.300	12364A
4*	bearing, I/B - XS4	312.011.350	S1088
5	housing, bearing, XS4 - C/I(std)	312.010.450	38251-411-10000
7	vent, air	310.010.600	S1530 w/bushing
8*	o-ring - Buna	312.011.600	S1674
8*	o-ring - Viton	312.011.601	25154-449
9*	bearing, O/B - XS4	312.012.350	S375
10	cap, bearing, XS4 - C/I(std)	312.010.950	38322-220-10000
11	shaft XS4 - std (sleeve type) Δ	312.011.150	38514-817-16040
11	shaft XS4 - 17-4 (no-sleeve design) ▲	312.011.160	38514-819-1706H
13*	oil seal O/B - Nitrile	310.011.250	S1352
14	retaining ring, bearing	310.012.150	S442
15	o-ring - Buna	310.012.500	25154-022 (S2088)
15	o-ring - Viton	310.012.501	25154-022
16	shims, impeller	310.011.500	37J-17090
17*	gasket, bearing cap, XS4	312.012.050	38683-271-18000
18*	oil seal I/B - Nitrile	310.011.250	S1352
19	casing S4,XS4 - C/I(std)	312.030.000	46472-705 (10525-B)
20*	wear plate S4,XS4 - std	312.210.000	10532A-15990
20*	wear plate S4,XS4 - CD4	312.210.004	10532A-1718H
21	seal plate S4,XS4 - C/I(std)	312.011.900	38272-234-10010
21	seal plate S4,XS4 - CD4	312.011.904	38272-234-1718H
22	screw, impeller - std	310.011.700	F1004S-1500G
22	screw, impeller - SS	310.011.701	F1004S-1704G
23	washer, impeller - std	310.011.800	31167-029-16000
23	washer, impeller - SS	310.011.801	31167-029-1706H
24*	check valve S4,XS4 - STD	312.120.000	46411-062
24*	check valve S4,XS4 - Viton	312.120.001	46411-072
25	pin, check valve S2,S4,XS4,I4	310.100.000	11557-17010
26*	o-ring - Buna	312.011.600	S1674
26*	o-ring - Viton	312.011.601	25154-449
27	sight gauge	310.011.400	S1471
28	screw, rot.ass'y adj.	310.080.000	
29*	gasket, fill cover (all but S12)	310.280.000	50G-19210
30	gasket, suction flg. S4,XS4,I4	312.090.000	11389G-19370
31	gasket, disch. flg. S4,XS4,I4	312.040.000	25113-034
33	fill cover kit - std (bar,plate,gask,scrw)	310.350.000	
34*	o-ring - Buna	312.012.600	25152-273
34*	o-ring - Viton	312.012.601	25154-273
38	cover (clean-out) S4,XS4 - C/I(std)	312.130.000	42111-903
39	spool, suction S4,XS4,I4 - C/I(std)	312.110.000	12066-10010
40	spool, discharge S4,XS4,I4 - C/I(std)	312.070.000	12066A-10010

**Notes:**

- 1a. p/n 310.010.310 mechanical seal, cartridge - includes sleeve o-ring, impeller shim set & sleeve.
- 1b. p/n 310.010.300 mechanical seal, component - includes sleeve o-ring, impeller shim set & NO sleeve.
- 2. parts are FOB Jacksonville, FL
- 3. \* indicates recommended spares

July 2017